



**Aviation
Ground
Equipment Corp.**

it's all about connections



Illustrated Parts List

Hobart 2400 Power Coil 400 Hz Ground Power Unit & Cable Retriever System



324 South Service Road, Unit 104 Melville NY 11747

TEL (631) 815-5520 • FAX (631) 815-5526

E-mail: sales@aviationgroundequip.com

Web: www.aviationgroundequip.com

Hobart 2400 Power Coil – 60 - 90 kVA

Illustrated Parts List

10.0 Illustrated Parts List

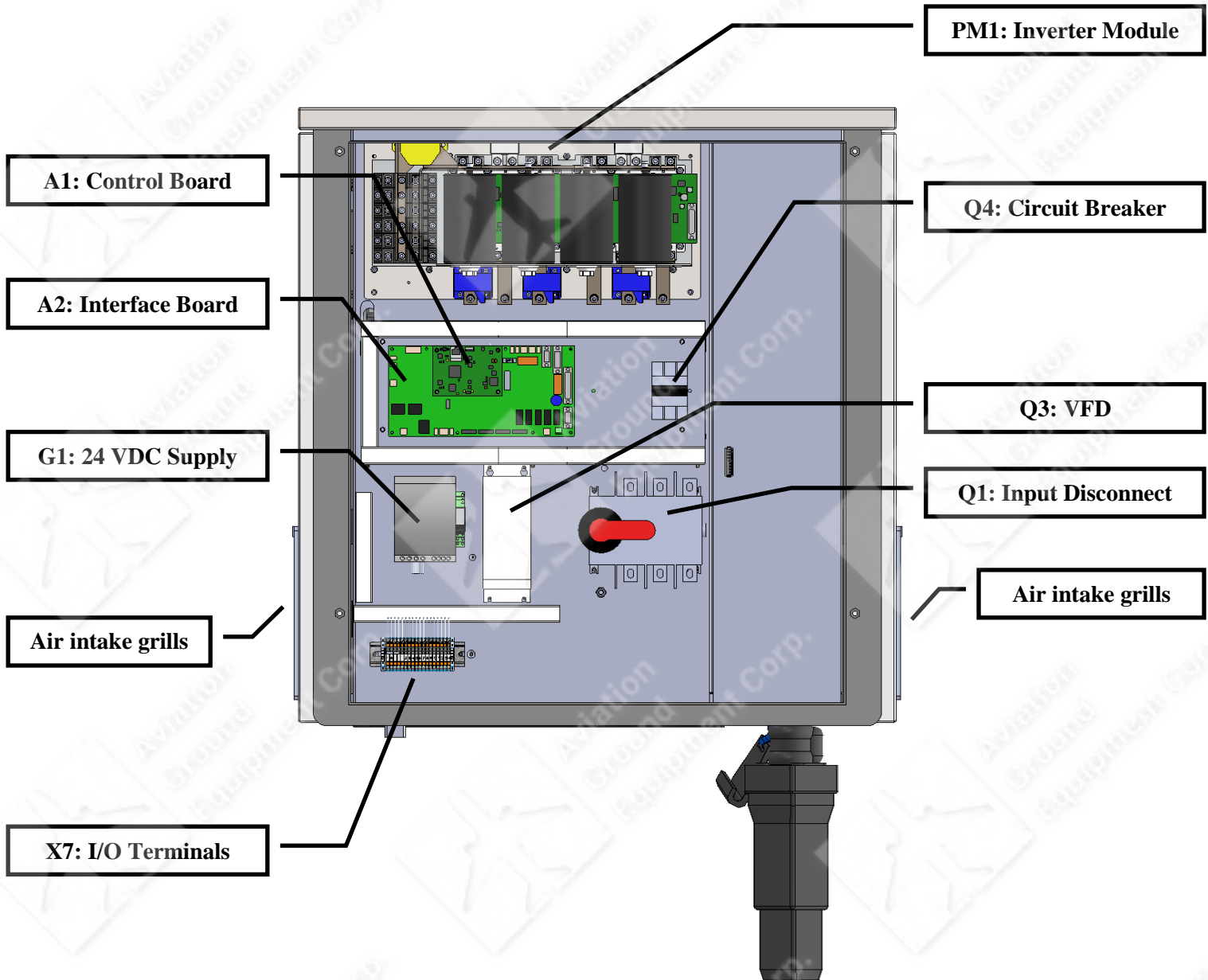

Figure: 1.0.1 Rear View (Electronic Zone)

Hobart 2400 Power Coil – 60 - 90 kVA

Illustrated Parts List

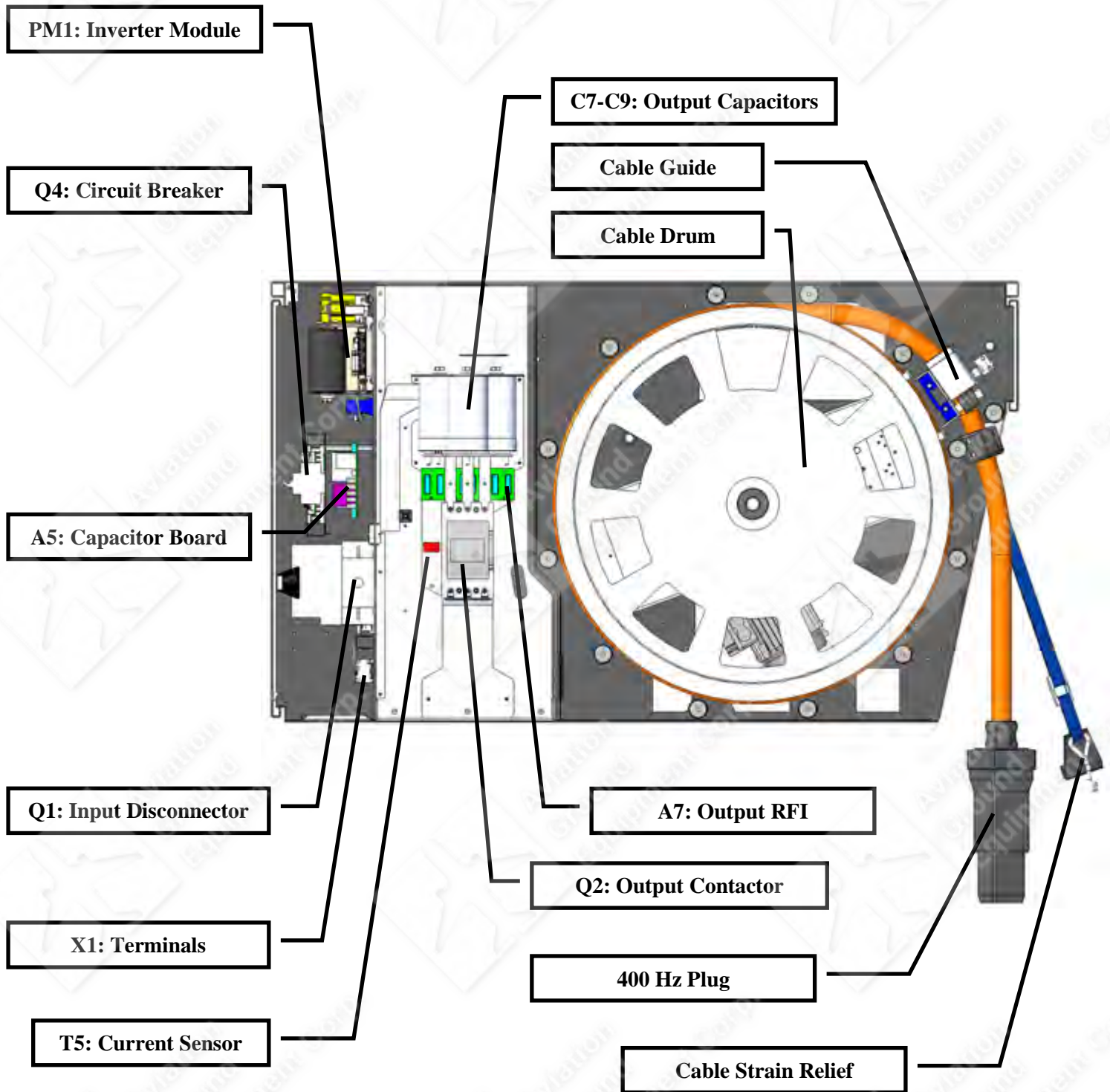

Figure 1.0.2 Left Hand Side View

324 South Service Road, Unit 104 Melville NY 11747

TEL (631) 815-5520 • FAX (631) 815-5526

E-mail: sales@aviationgroundequip.com

Web: www.aviationgroundequip.com

Hobart 2400 Power Coil – 60 - 90 kVA

Illustrated Parts List

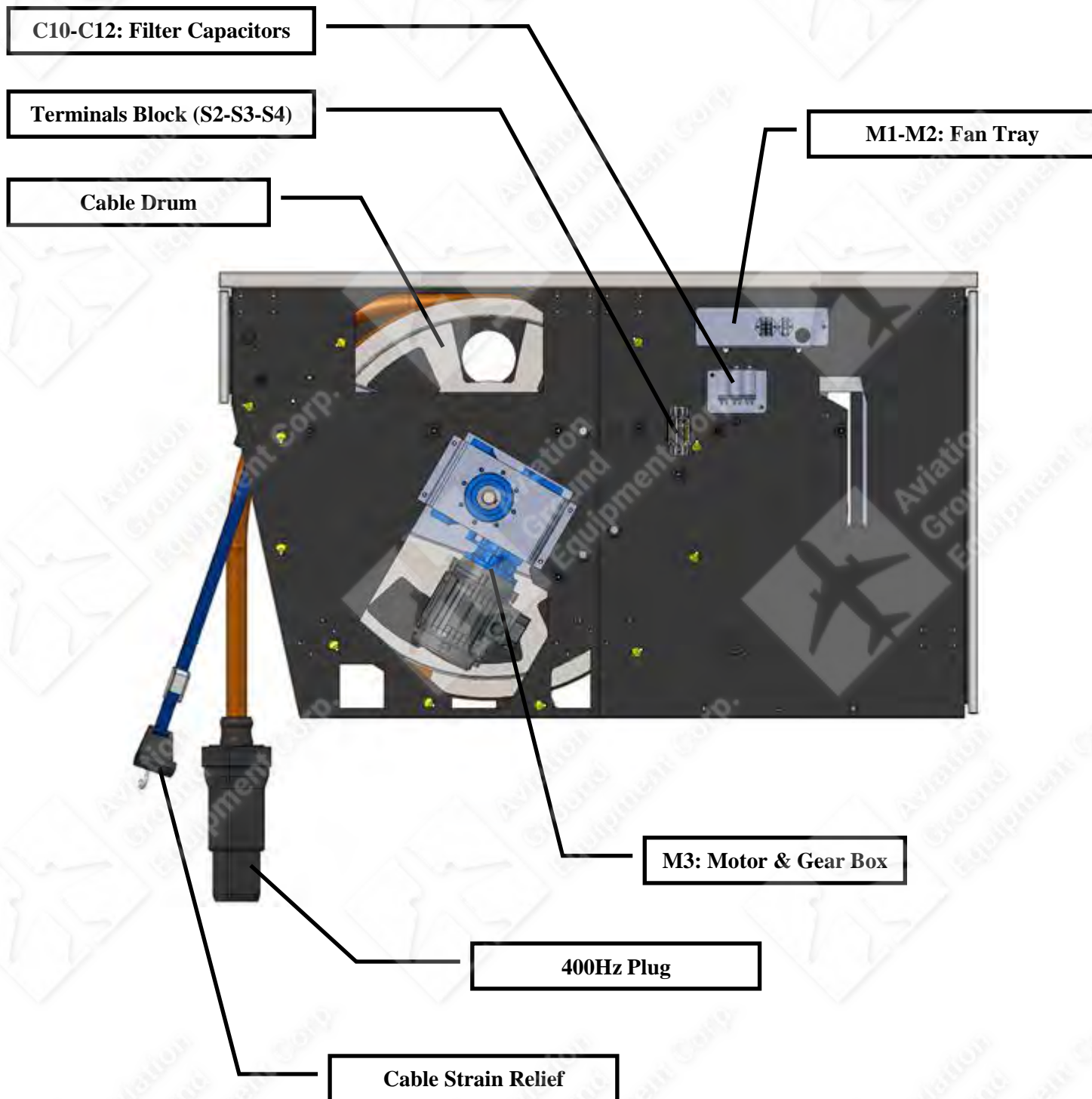

Figure 1.0.3 Right Hand Side View

324 South Service Road, Unit 104 Melville NY 11747

TEL (631) 815-5520 • FAX (631) 815-5526

E-mail: sales@aviationgroundequip.com

Web: www.aviationgroundequip.com

Hobart 2400 Power Coil – 60 - 90 kVA

Illustrated Parts List

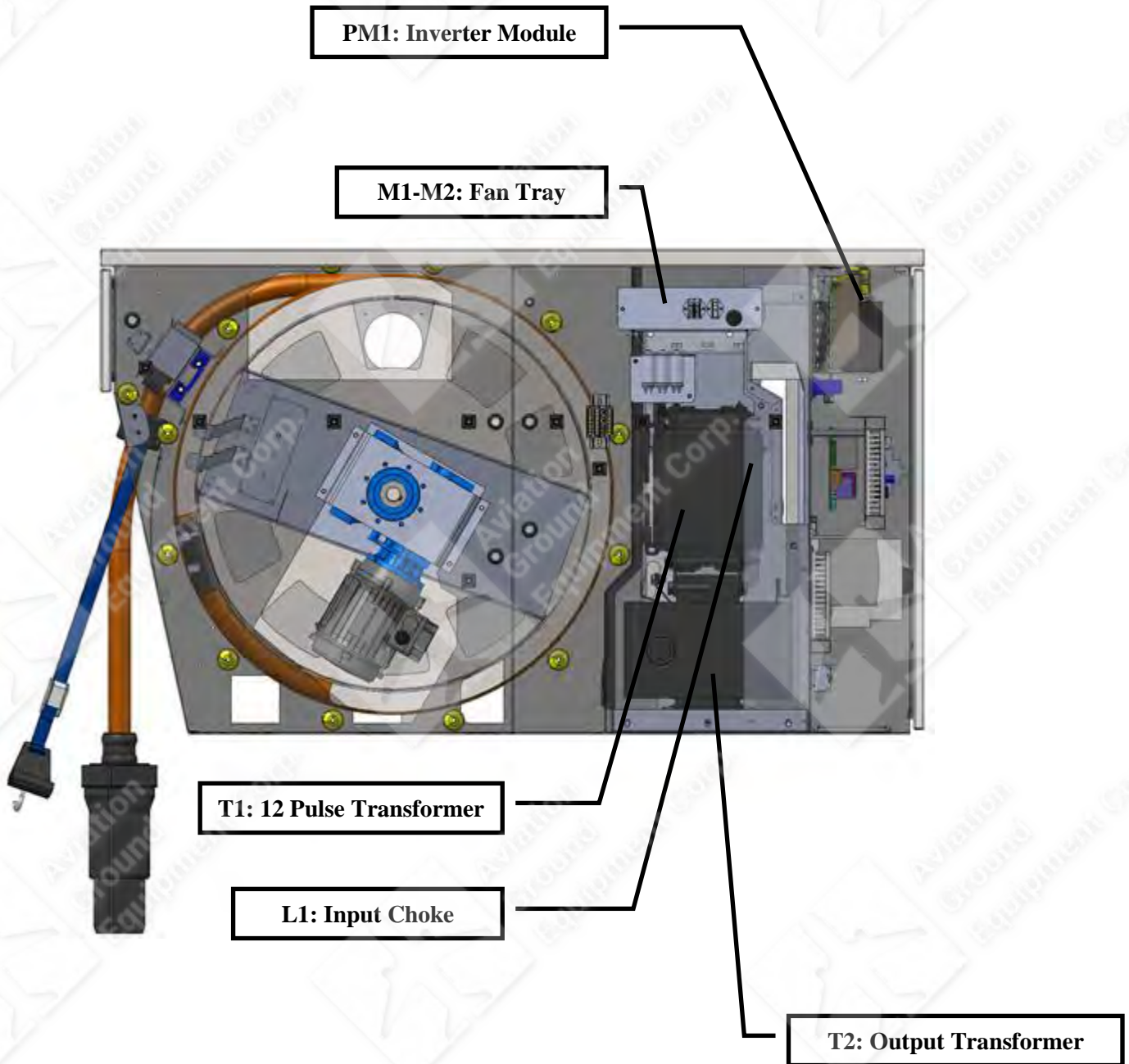

Figure 1.0.4 Right Hand Side View (X-Ray view)

324 South Service Road, Unit 104 Melville NY 11747

TEL (631) 815-5520 • FAX (631) 815-5526

E-mail: sales@aviationgroundequip.com

Web: www.aviationgroundequip.com

Hobart 2400 Power Coil – 60 - 90 kVA

Illustrated Parts List

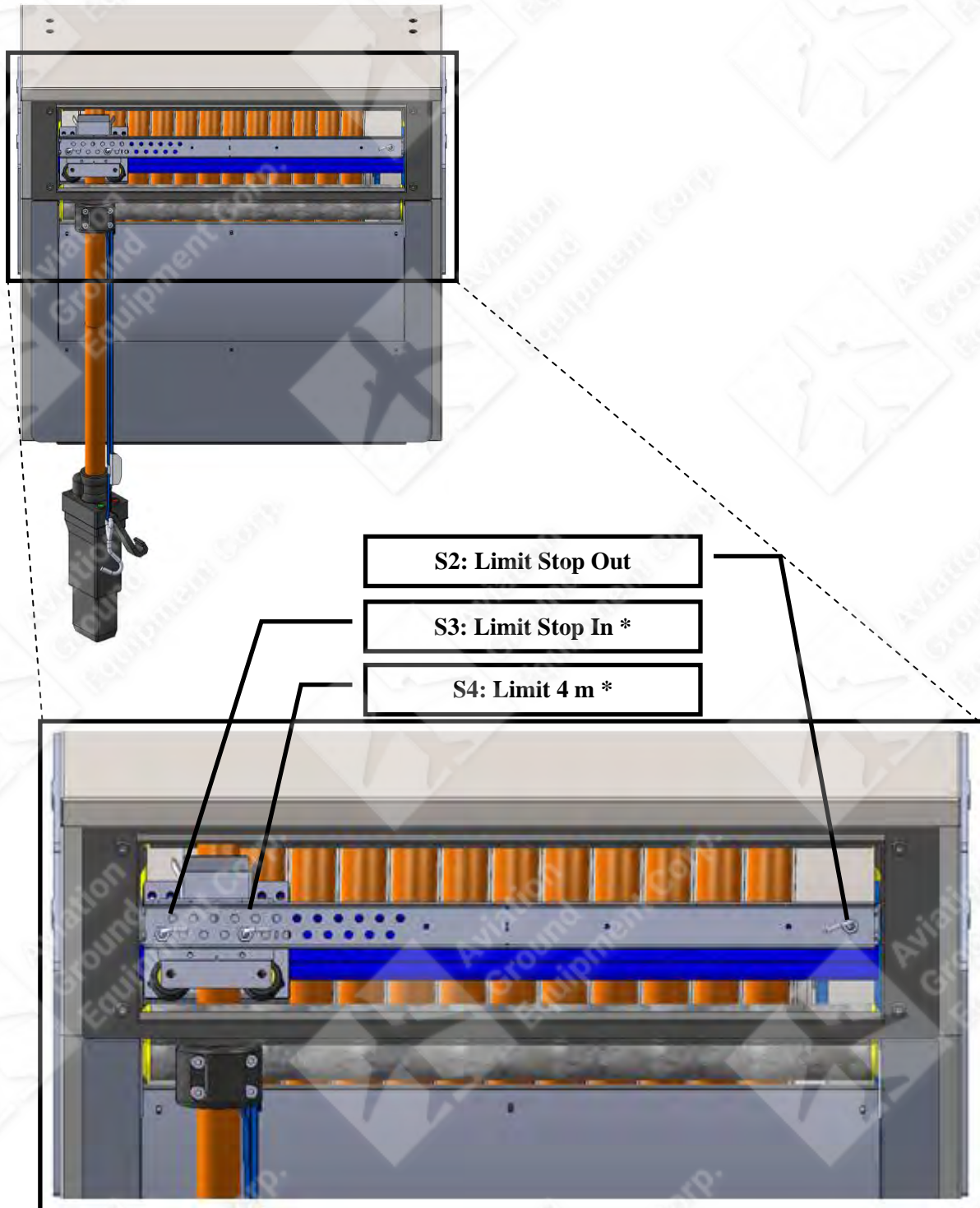

* Position of limit switches S3-S4 may vary depending on cable length.

Hobart 2400 Power Coil – 60 - 90 kVA

Illustrated Parts List

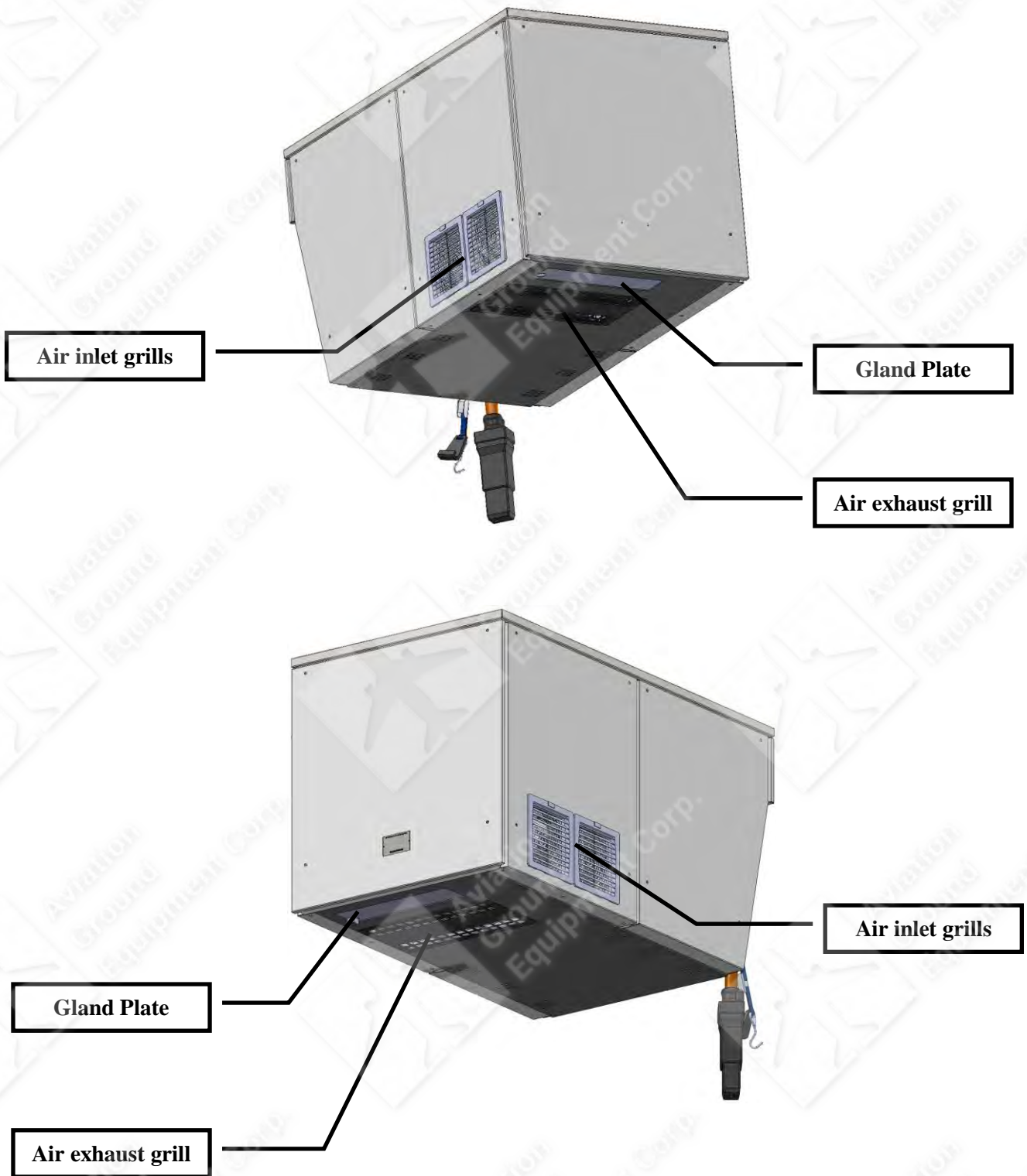

Figure 1.0.6

Hobart 2400 Power Coil – 60 - 90 kVA

Options

11.0 Options

AP-577801

Remote Control Box

The Remote Control Box is used for operation of the Hobart 2400 Power Coil especially if the 400 Hz cable is out of reach, often attached at the passenger boarding bridge.

Note !

The Remote Control Box must always be supplied and connected to the Hobart 2400 Power Coil, for the unit to be operational.

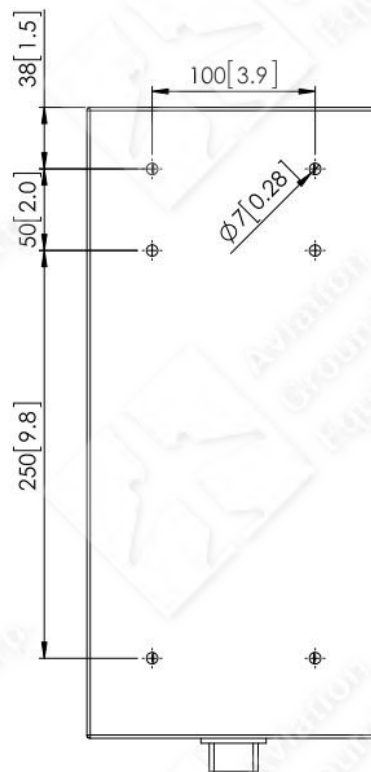
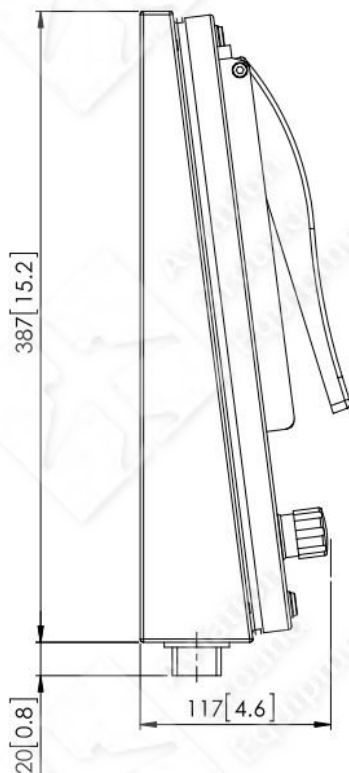
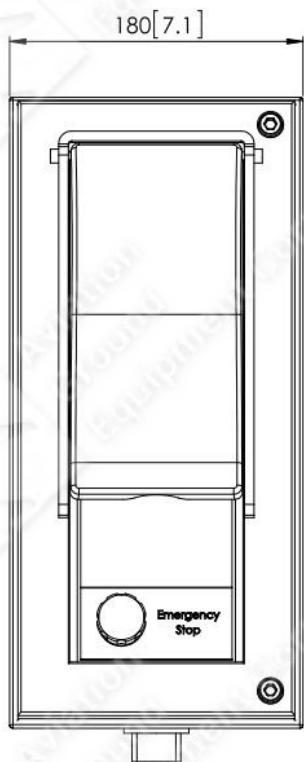
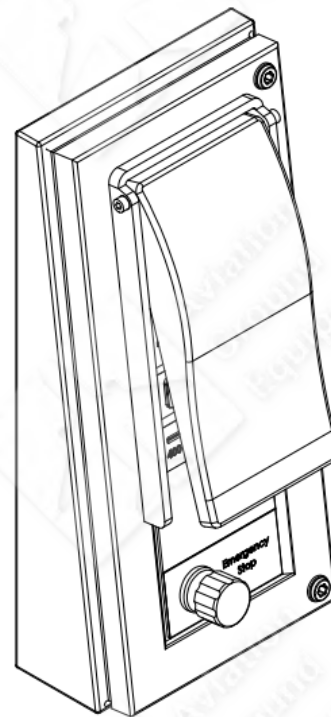

Hobart 2400 Power Coil – 60 - 90 kVA

Options

AP-577805

Door Switch (Diagram 477800)

The door interlock ensures that the ground power units output contactor(s) open and the unit immediately returns to standby mode if the door is opened.

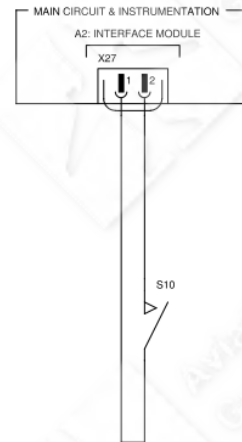

AP-591100

Auto Calibration Plug

Required for Plug & Play set-up.
See section 7.

